

Since 1968

Home Network
COMMAX

COMMAX



User Manual

Nurse Call System
JNS-PSM

COMMAX Co.,Ltd.

513-11, Sangdaewon-dong, Jungwon-gu, Seongnam-si, Gyeonggi-do, Korea
Int'l Business Dept. : Tel.; +82-31-7393-540~550 Fax.; +82-31-745-2133
Web site : www.commax.com

Printed In Korea / 2010.04.101

www.commax.com

COMMAX Co.,Ltd.



- Thank you for purchasing COMMAX products.
- Please carefully read this User's Guide (in particular, precautions for safety) before using a product and follow instructions to use a product exactly.
- The company is not responsible for any safety accidents caused by abnormal operation of the product.

Table of Contents

1. System Introduction	2
2. System Capacity	2
3. System Feature	2
4. Signal & Lamp Specification	3
5. Function & Operation	3
5.1 Bed Paging	3
5.2 Sub Station	3
5.3 Room Broadcasting	3
5.4 Presence Switch	4
5.5 Emergency Switch (Toilet in patient room)	4
5.6 Emergency Switch (Shower Room)	4
5.7 Staff Call	4
5.8 Emergency Switch (Corridor Toilet)	4
6. How to set up the characterized Number	4
6.1 Interphone	4
7. Bed Programming	5
7.1 Bet No. and Inductor Set up	6
8. Installation	6
8.1 Summary	6
8.2 Work Condition	6
8.3 How to install between DSS and Master Station	7
8.4 How to install the Master Station	7
8.5 Bed connection	7
8.5.1 Bed Connection	7
8.5.2 Toilet Emergency Switch	7
8.5.3 Shower Room Emergency Switch	7
8.5.4 Presence Switch	7
8.5.5 Corridor Light	7
8.5.6 Corridor Toilet	7
8.5.7 Inductor	8
8.5.8 Interphone	9
8.5.9 Receiver	9
9. Nurse Call System	10
9.1 System Schematic	10
9.2 System Wiring Diagram	11
9.3 Parts Name and Connecting Method	12
9.4 System Connection Schematic	13
9.5 Dimension	14
9.6 Fitting Materials	18



Warnings and caution

☉ Make sure to follow the instructions to prevent any danger or property losses.



Warning Death or serious injury is expected.



It indicates prohibition.



It indicates prohibition of disassembly.



It indicates prohibition of contact.



It indicates dos and don'ts.



It indicates that the plug should be pulled out from the socket.



Warning

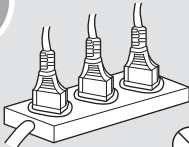

Prohibition

Do not put the plug in the socket simultaneously.

It may generate abnormal heat or cause a fire.

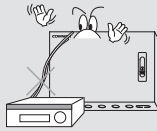

Prohibition

Do not connect to other products while in use.

It may cause breakdown.

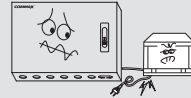

Prohibition

Do not forcibly bend the cord or put a heavy object on the product.

It may cause a fire.

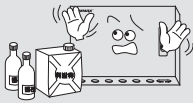

Prohibition

Do not use water, thinner or a detergent used to wash oil products when you wash the exterior.

Make sure to wash it by using a dry cloth to prevent any breakdown or electric shock.



Prohibition

Do not install the product in a humid place.

It may cause an electric shock or a fire.



Prohibition

Do not forcibly pull out the cord from the socket.

If the cord is damaged, it may cause a fire or an electric shock.



Do not contact.

Do not put the plug in the socket with a wet hand.

It may cause an electric shock.

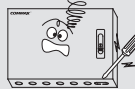

Do not disassemble

Do not disassemble, repair or modify the product.

It may cause a fire, an electric shock or an injury due to malfunction of the product.

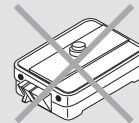

Do not use AC circuit breaker.

It may cause an electric shock.

Warnings and caution



Caution An injury or property losses are expected

- It indicates prohibition.
- It indicates prohibition of disassembly.
- It indicates prohibition of contact.
- It indicates do's and don'ts.
- It indicates that the plug should be pulled out from the socket.



<p>If the socket holes are larger than normal, do not put the plug. It may cause an electric shock or a fire.</p>	<p>Make sure that dust or foreign substances are not gathered on the product.</p>	<p>Make sure to prevent foreign substances from entering the product. It may cause a breakdown.</p>
<p>Do not put a heavy object on the product. It may cause a breakdown.</p>	<p>Do not disassemble or give an impact to the product.</p>	<p>Avoid direct rays of the sun or heating devices at a time of installation.</p>
<p>Install the product in a flat and stable place. Otherwise, it may not function properly.</p>	<p>Pull the plug if the product is not used for a long time.</p>	<p>If the product generates strange sound, make sure to pull the plug immediately and contact COMMAX service center.</p>

1. System introduction

This system was designed to exchange the communication between Nurse and patient with Master station and sub station by data communication system

This system was composed with master station which can control and display in the system and Power controller, and the sub station was composed with 4 wire type and it can be covered maximum 32 ea sub station from 1 mater station, and It can be installed the presence switch, emergency switch and corridor light.

2. System Capacity

2.1 System Capacity

- Sub Station: 32ea / Each Patient Room
(Consisted of: Presence S/W (1), Emergency S/W (2), 2 Color Corridor Light (1))
- Emergency Display for Corridor Light: 16 Circuits
- Inductor: 4-way indication lamp
- Interphone (Master Station): 90 Circuits

2.2 System Dimension

- Master Station: 240 (L) x 200 (W) x 90 (H)mm
- DSS: 240 (L) x 129 (W) x 70 (H)mm

2.3 Power Requirement

- Power Source: 220V
- Input Frequency: 57Hz ~ 63 Hz
- Power (Emergency): DC 24V, 6.5A

3. System Feature

3.1 Digital control type

3.2 The end user can put the programming of BED no and room no by end user 's control, and in case of emergency case, everybody know the place clearly.

3.3 Speaker phone function

3.4 The mater station can be covered the sub station (MAX 48ea from 1 master station)

3.5 16 Digit 2 line LED DISPLAY (Year, months, time, display)

3.6 In case of main power off, there have a EEPROM to keep the program, no need the re- programming

3.7 The corridor lamp display by 2 color lamp or 3 color lamp (emergency and normal case)

3.8 Each mater station can be communicated



4. Signal and Lamp Specification

Section	LCD	LED	SOUND	Corridor Light
Communication	Call : XXXX	Steady Green		
Bed Paging	Call : XXXX	Flashing Green	Melody Sound	Flashing White
Toilet (Room)	Emerg : XXXX	Flashing Red	Emer. Sound	Flashing Red
Toilet (Corridor)	Emerg : XXXX	Flashing Red	Emer. Sound	Steady Red
Presence S/W		Steady Green		Steady White
Staff Paging	Staff : XX	Flushing Ginger	Police Sound	Steady White Flashing Red
Interphone	Process AN90 : XX		Telephone	

*If the situation will occur simultaneously, corridor light and master station lamp will blink at once.

(Corridor light, shower room, bed, interphone will blink by turns)



5. How to use and Function

5.1 Bed Paging

- Lift up the handset or press the programmed dial button to answer the call.
- Press the Dial Button to Communicate with each Bed.
- While in conversation, Green led lamp will turn on and Call xxxx-Bed no will be displayed
- Can be communicated with patient in sub station directly

5.2 Sub Station Function

5.2.1 Communication with master station and sub station

- Put the call button in sub station to communicate with master station, and then green lamp will be lighted and white lamp in corridor will be lighted (in that case, the Led lamp in master station & alarm is warning)
- Put the cancel switch to cancel the communication in sub station (LED in master station display as Sub cancel REQ)

5.2.2 Lift up the Handset in Master station for Communication. (Corridor Light will be off)

5.2.3 If the master station is on line, it will automatically flash the green led on the bed for its conversation. If press the call button, it will be reserved with the alarming of red lamp, and then it will be automatically connected after the previous conversation.

5.3 Room broadcast function

- Put the all paging and group call, each bed is on broadcast, so, it can be use the Group call with master station.
- In case of using the group call, cannot be use the general call, however, Emergency switch in toilet, shower room and presence switch is normally operated.

5.4 Presence switch

5.4.1 For emergency case, the nurse put the presence switch to inform the location with corridor lamp function and notifying to be reply for the master station's call.

5.4.2 If the presence switch is on, the corridor lamp will be on display the master station.

5.4.3 To cancel the presence switch, put the presence switch it again.

5.5 Emergency switch (For toilet use)

5.5.1 For emergency case, push the switch to announce the emergency.

5.5.2 If that case, the corridor Lamp is on, display the master station with red lamp.

5.5.3 To cancel the emergency switch, put the emergency switch it again.

5.6 Emergency shower switch (For shower room use)

5.6.1 For emergency case, push the switch to announce the emergency.

5.6.2 If that case, the corridor lamp is on, Display the master station with red lamp.

5.6.3 To cancel the emergency switch, Put the emergency switch it again.

5.7 Staff Call Function

5.7.1 In emergency, nurse in a patient room can announce the emergency to nurse station through the call button in sub station.

5.7.2 If the presence switch is on, white corridor lamp will be automatically lighted and red corridor lamp will blink.

5.7.3 To cancel the presence switch press the off switch.

5.7.4 The conversation can be available when the master station receive the call, it will be a presence position.

5.8 Emergency Switch (Corridor Toilet)

5.8.1 For emergency case, push the switch to announce the emergency, it can be connected 16ea with the master station.

5.8.2 If that case, the corridor Lamp will be lighted, display the master station with red lamp.

5.8.3 It will be alarmed directly from the master station, red LED in corridor toilet will blink.

5.8.4 To cancel the emergency switch, Put the emergency switch it again



6. How to set up the characterized Number

The system is a data communication system though the Microprocessor, it should be set up the characterized number to be functioned.

6.1. Interphone.

- The DIP switch in CDS-90AN PCB shall be set up by binary numbers.

(It can be set up from No. 10 to No. 99) – Refer to the related drawing no. 9-4

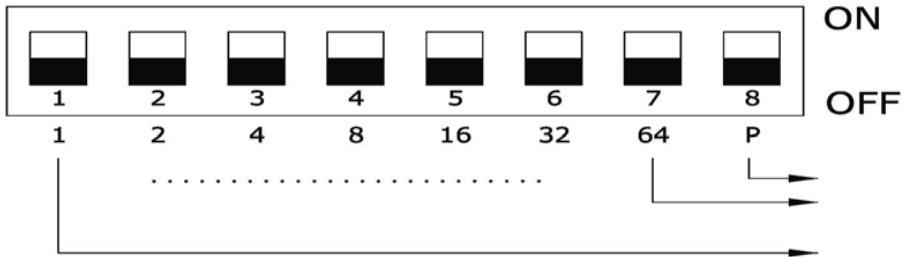

- 1 - Switch (Interphone No.1)
- 64 - Switch (Interphone No.64)
- P - Reject switch for receiving the interphone broadcast

For example) No. 43 can be received the interphone broadcast ($1+2+8+32=43$)

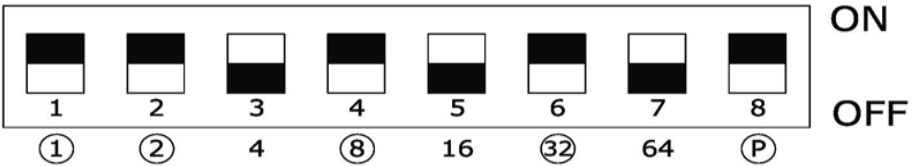

For example) No. 43 can not be received the interphone broadcast ($2+8+16+64=90$)

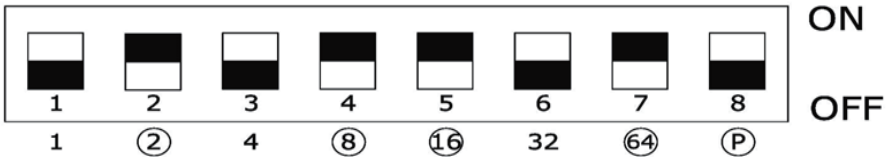

7. Bed Programming

*The system can be operated by programming, after the DIP switch set up completely.

- 1) Programming can be available only on waiting position (Standby).
- 2) While in programming, the system shall not be operated.
- 3) It shall be paging from the bed for testing. (Refer to the drawing no. 9-4)
- 4) After completion, the system will be ready to communicate.

7.1 Bed No. and Inductor.

- Press the mode button. ("password" will blink on the display window)
- Enter the password (9999). ("Program" will blink on the display window)
- Enter the code (00). ("pr00[0000]" will blink on the display window)
- Use the button to be displayed pr010000]
- Pr02 indicate the bed no., it can be input up to no.32.
- Press the call button from bed to communicate with the master station, CALL>XXXX-XX will blink on the display window, and then lift up the handset to input the bed no. If press the remote-control button, it will be displayed as the following.

ID=1	GRP=2	LP=3
------	-------	------

- If press "1" button, ADDR>XXXX-XX will blink on the display window, input the number and press the remote-control button.
 - If press "2" button, GROU>-XX will blink on the display window, input the number and press the remote-control button.
 - If press "3" button, LAMP>-XX will blink on the display window, input the number and press the remote-control button.
- (No.1: Bed no. No.2: Special Group (Surgery, Labour, etc.) No.3: Inductor Group)



8. Installation Work

8.1 Summary

Describe the method of installation for a proper operation of Nurse call system and asafety of end user.

8.1.1 The system classify into three parts.

- 1) Master station and DSS for system operation
- 2) PCB Board and Control Circuit classified by power function
- 3) Bed to be installed in a patient room

8.1.2 All wires shall be connected individually.

8.1.3 Each bed can be complied with presence switch, emergency switch, emergency shower switch and two colored corridor light.

8.1.4 Corridor toilet can be connected up to 16 ea.

8.1.5 Interphone shall be wired by 10 piece and installed up to 90 ea.

8.2 Work Condition

The system consists of the various electronic components, while its installation.

8.2.1 Cable to be connected in mater station shall be installed at a proper place for the installation work and kept away from the direct rays of the sun.

- 8.2.2 Operating temperature shall be kept from 0C to 30C, Humidity shall be kept from 50% to 60%.
- 8.2.3 Power source shall be supplied at a convenient place for grounding and maintenance.
- 8.2.4 The system shall be installed to keep away from the electronic devices such as monitor, computer, etc.
- 8.3 How to connect between DSS and Master station
As the related drawing no. 9-3, insert the plate cable and fix with B. K. T.
- 8.4 How to connect among the Master stations Mater station shall be connected with 9 piece of cable.
- 1) Black : 24V
 - 2) Brown : GND
 - 3) Red : Call
 - 4) White : Receiver

8.5 Bed Connection

8.5.1 Bed Connection

- It shall be connected between bed and bed with 4P connector.

8.5.2 Emergency Switch (Toilet) Connection

- It shall be connected at the closest sub station, connected in 3P connector (CN6) no.1, 2.

8.5.3 Emergency Switch (Shower Room) Connection

- It shall be connected at the closest sub station, connected in 2P connector (CN8).

8.5.4 Presence Switch Connection

- It shall be connected at the closest sub station, connected in 3P connector (CN6) no. 1, 3.

8.5.5 Corridor Light Connection

- It shall be connected at the closest sub station from the presence switch, red lamp shall be connected in 3P connector (CN5) no. 2, white lamp shall be connected in 3P connector (CN5) no. 5.

8.6 Corridor Toilet Connection

The Corridor Toilet can be connected up to 16ea, refer to the following schematic for connection.

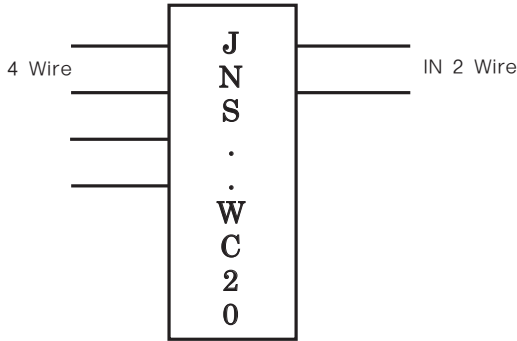

- 1) Input 2 wire (IN01, IN02 ... IN16) shall be connected at a switch.
- 2) Output 2 wire shall be connected at each functional switch, if each input will be functional, the related output will be lighted.

8.7 Inductor Connection

The inductor shall be connected as the following schematic.
 (Refer to the drawing no. 9-4)

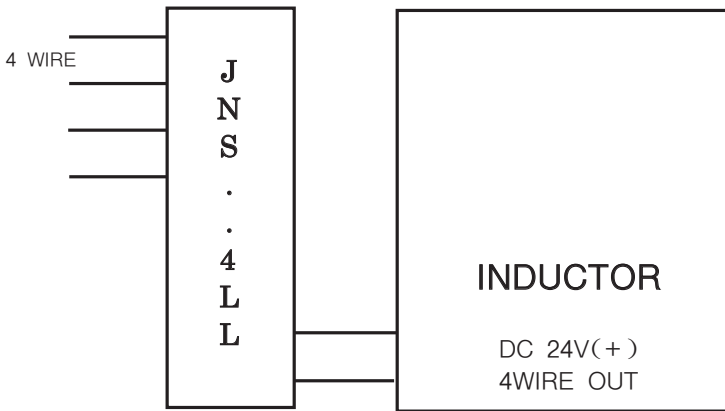

8.8 Interphone Connection

For TP-90AN connection or connection among the systems, the interphone shall be connected with 10 pieces of cable by parallel. (Refer to the drawing no. 9-4)

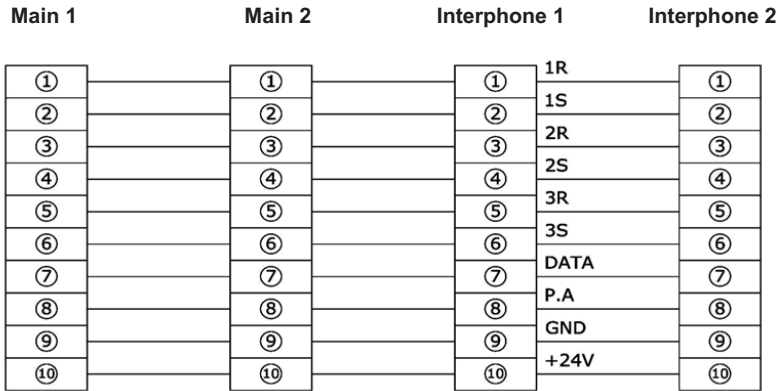

8.9 Receiver Connection

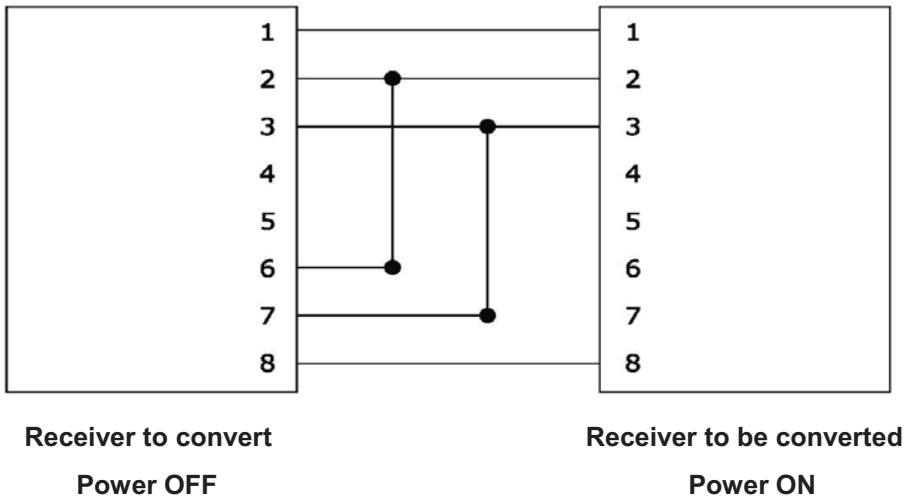



9. Nurse Call System

9.1 System Schematic

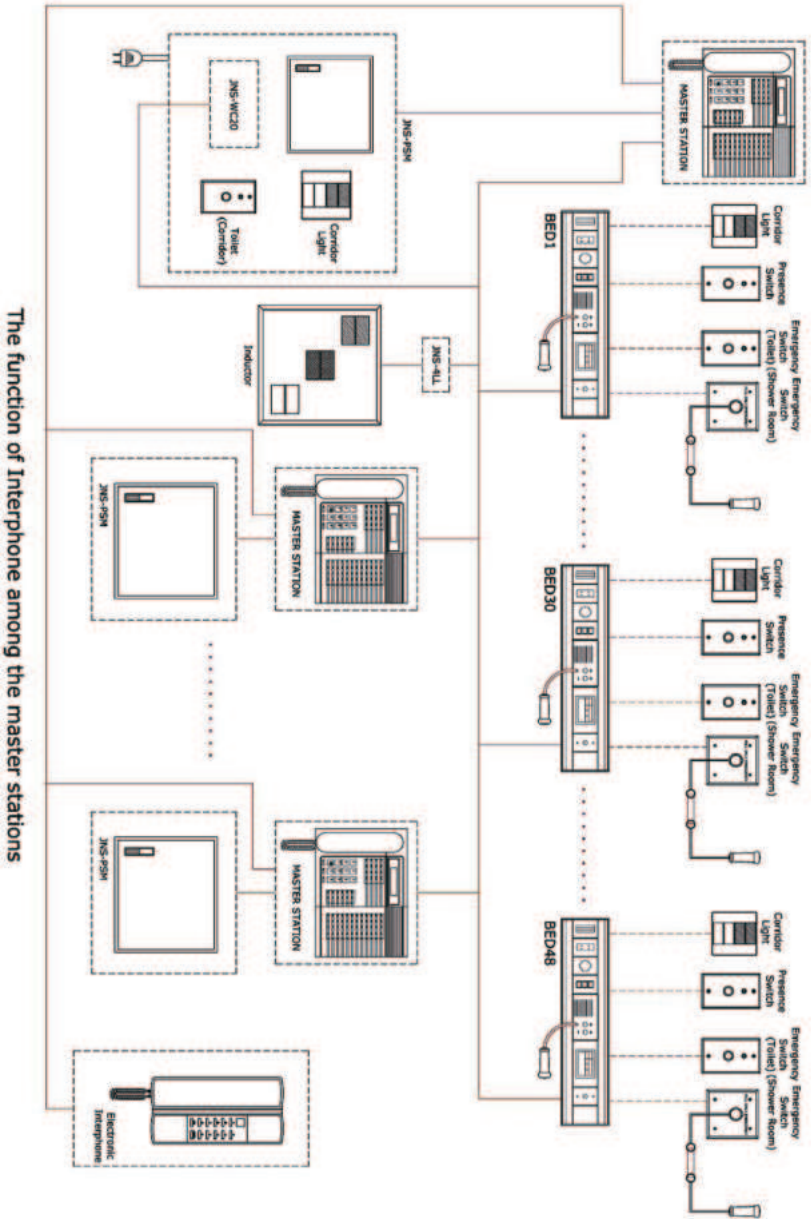

9.2 System Wiring Diagram

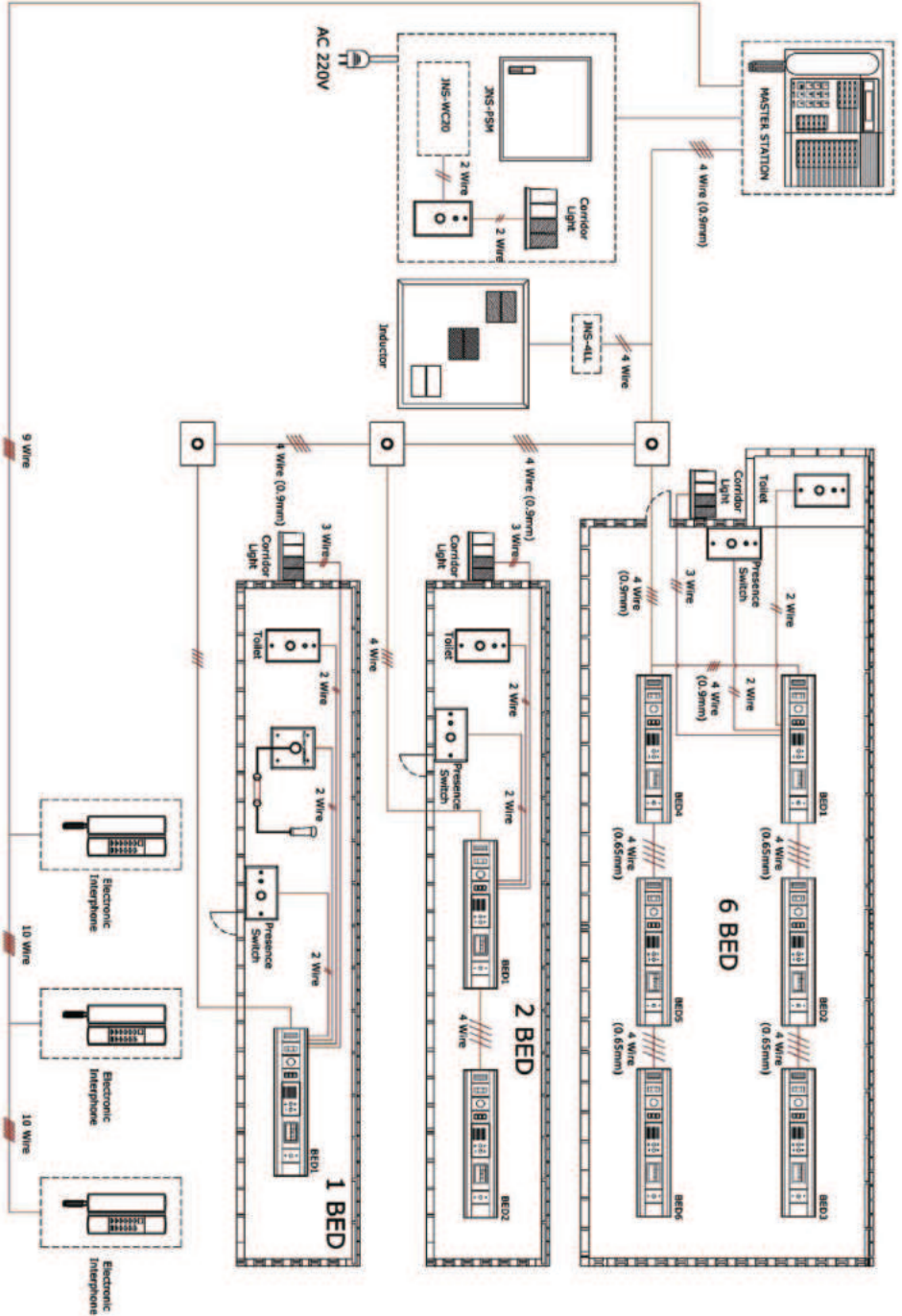

9.3 Parts Name and Connecting Method

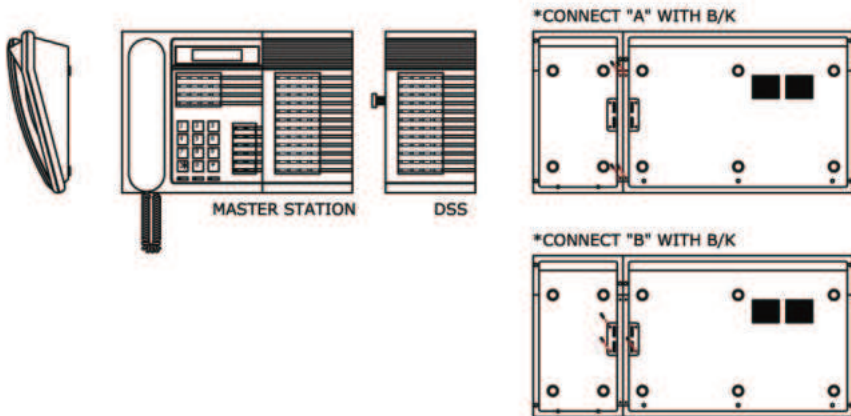
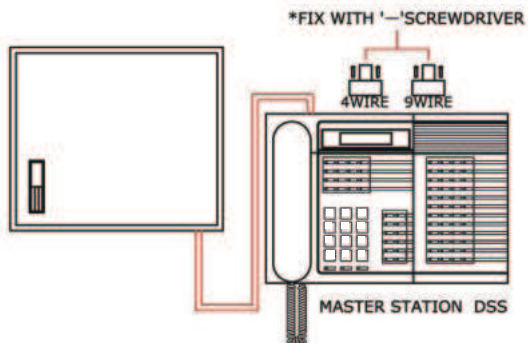
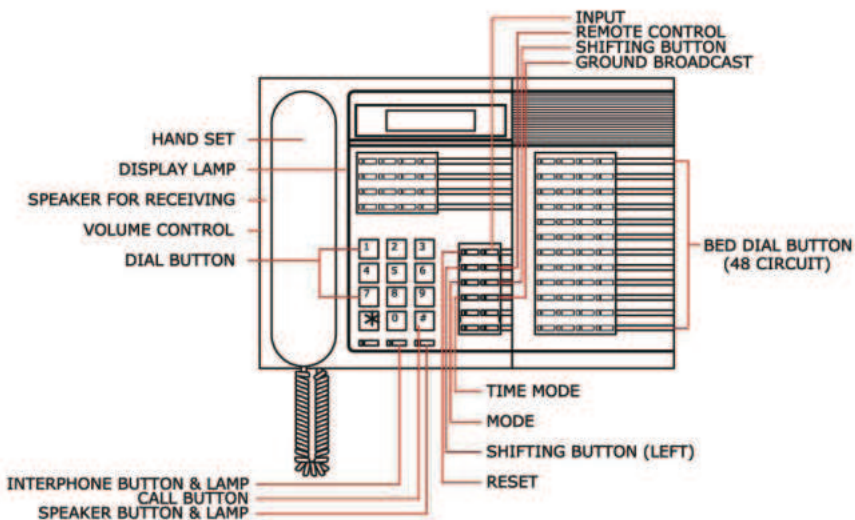

9.4 System Connection Schematic

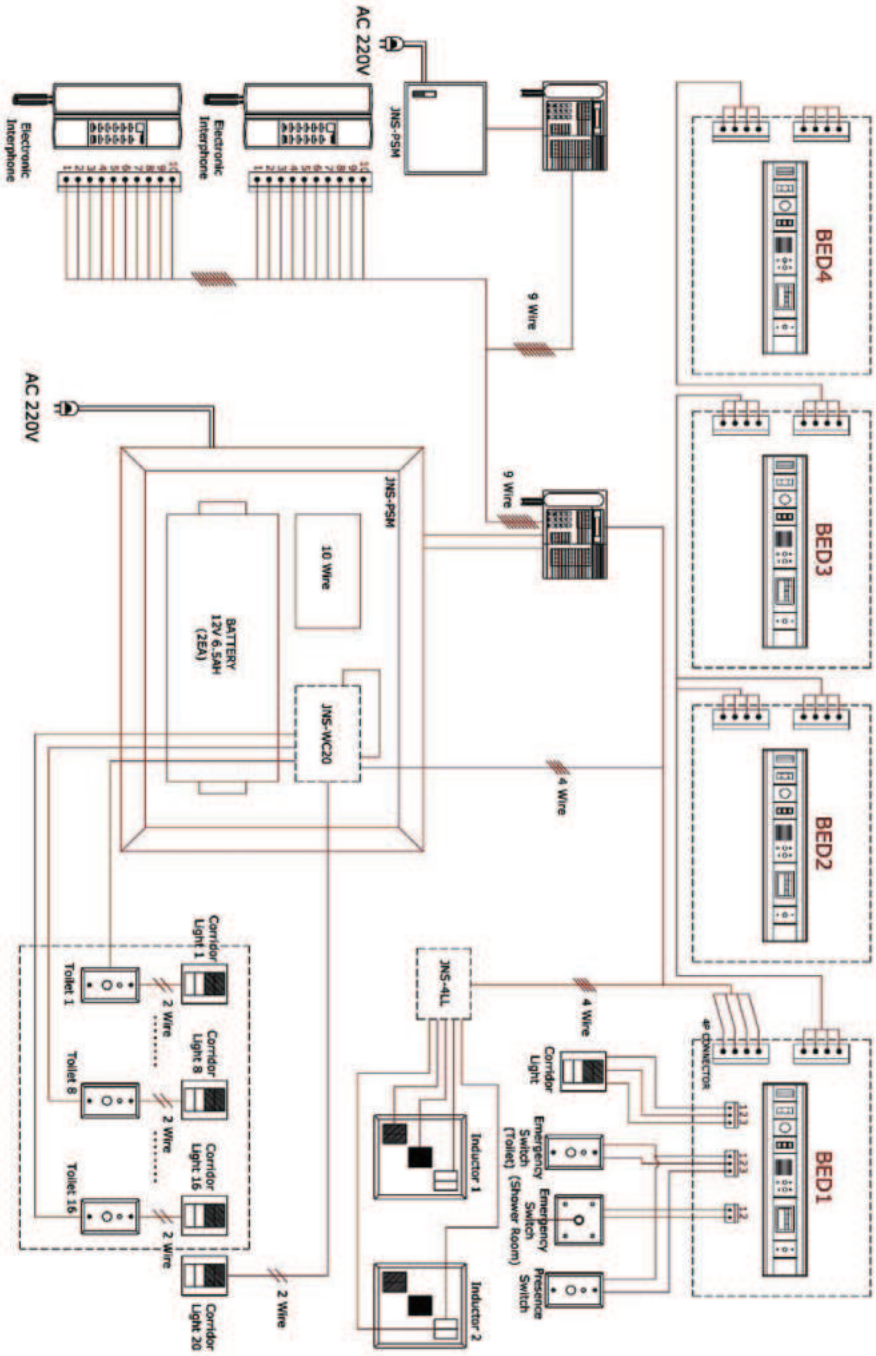

9.5 Dimension

9.5.1 Master Station (JNS - 1060)

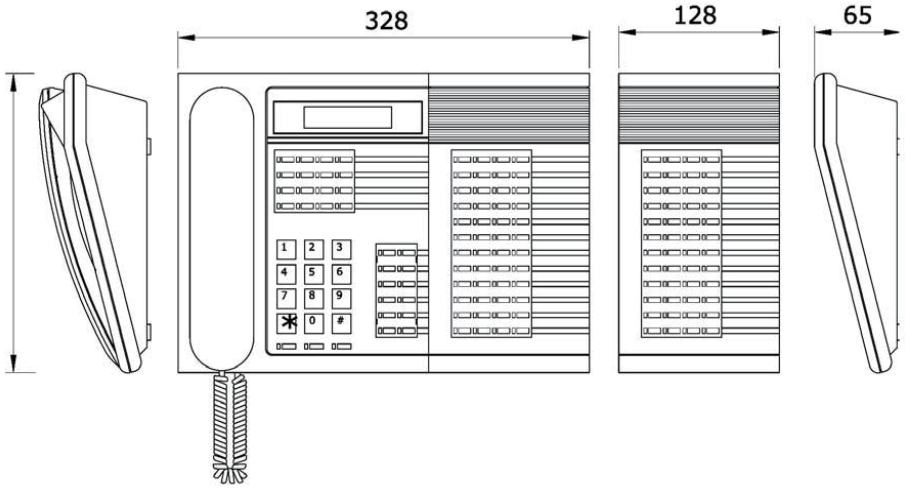

9.5.2 Main Control Panel (JNS - PSM)

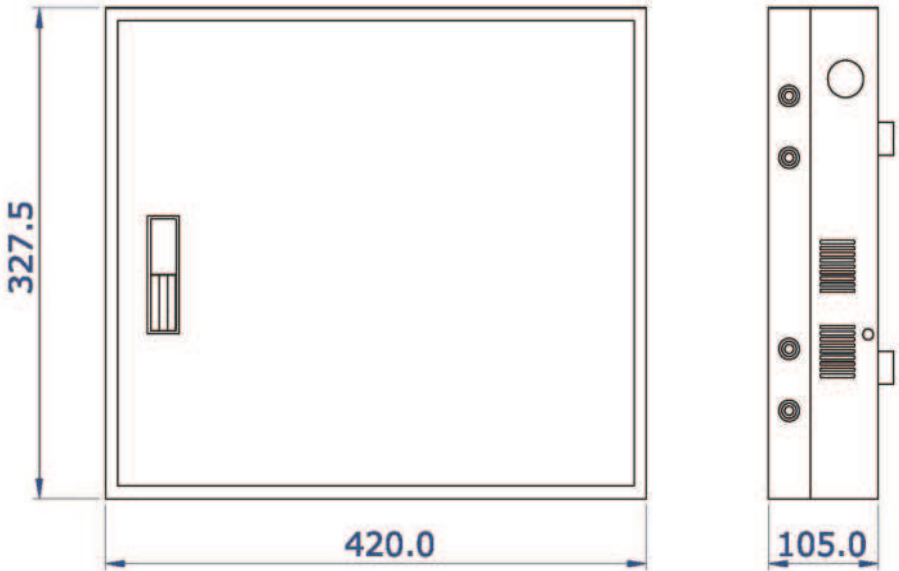

9.5.3 Console Bed (MGH - Series)

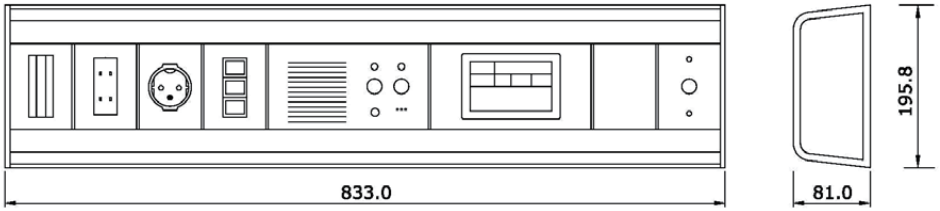

9.5.4 Sub Station (JNS - 101)

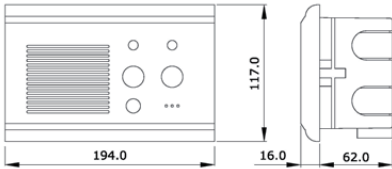

9.5.5 Emergency Switch (Toilet) (ES - 410)

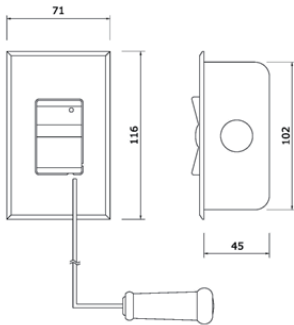

9.5.6 Emergency Switch (Shower Room) (ES - 420)

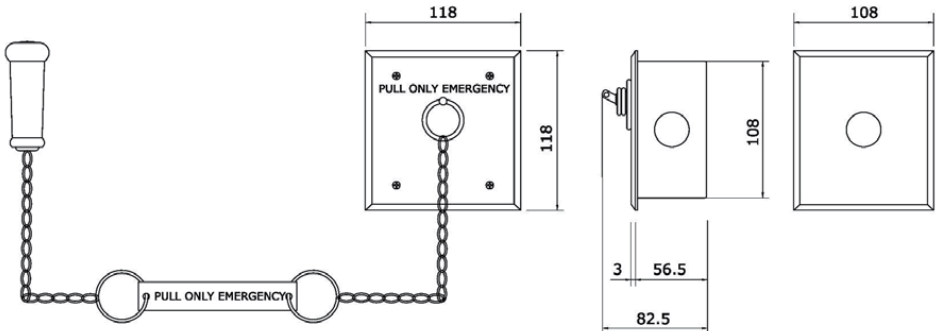

9.5.7 Presence Switch (PB - 500)

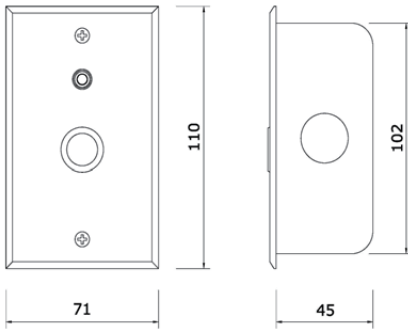

9.5.8 Inductor

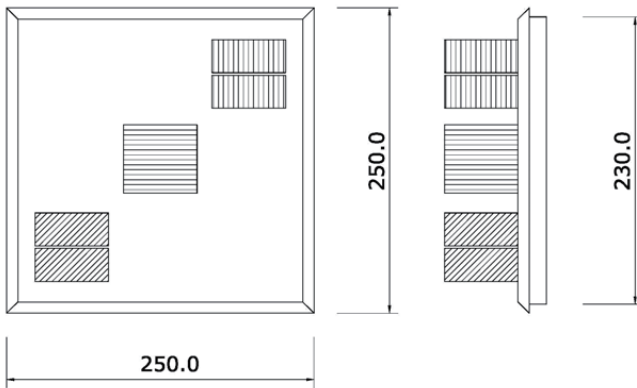

9.5.9 Corridor Light (CL - 302C)

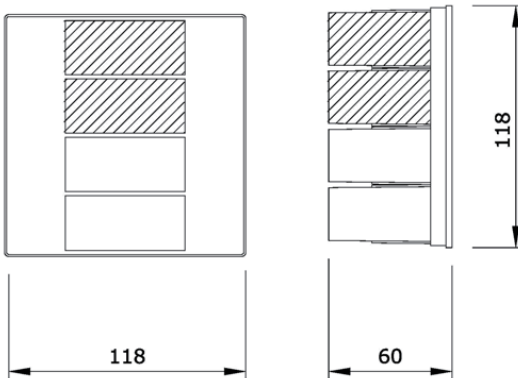

9.5.10 Interphone

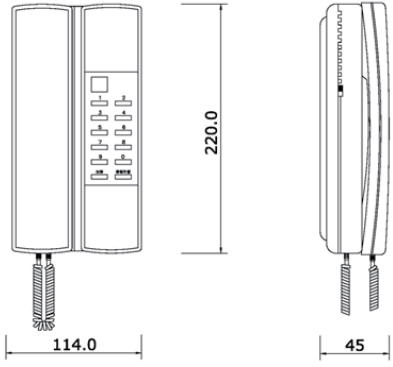

9.5.11 Bed Head Calling Unit (PS - 100C)

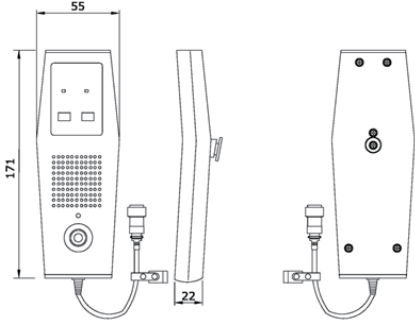

9.5.12 Call Code (CC - 200)

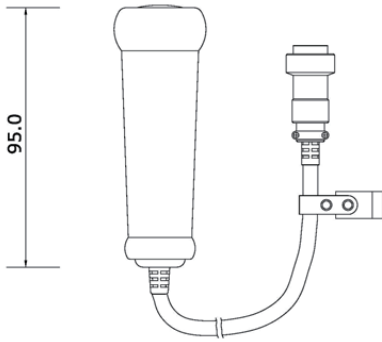

9.6 Fitting Materials

9.6.1 Coupling



9.6.2 Connector

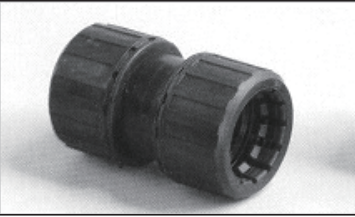

9.6.3 Flexible Hose

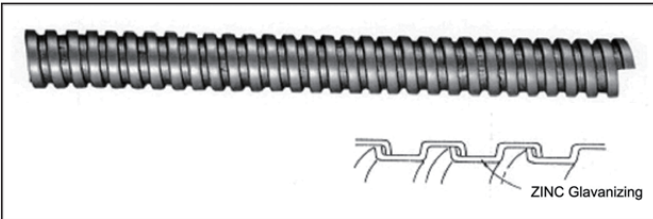

9.6.4 UPT Cable 4P

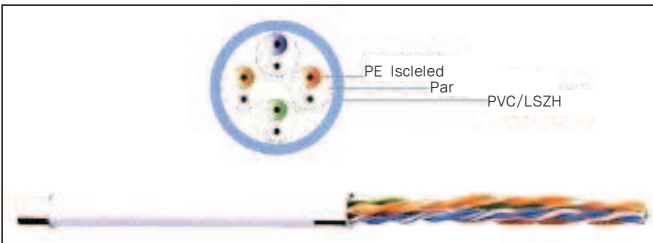

9.6.5 IV Cable 1.2mm

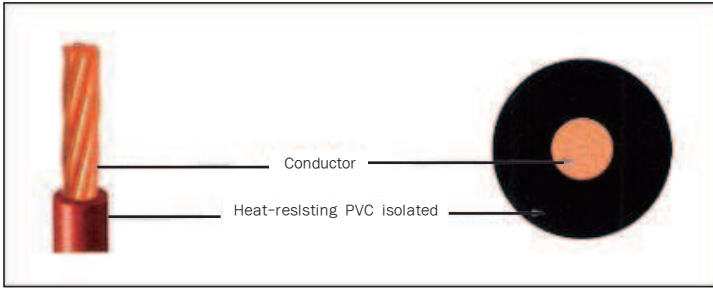

9.6.6 Concealed Box (Corridor Light)

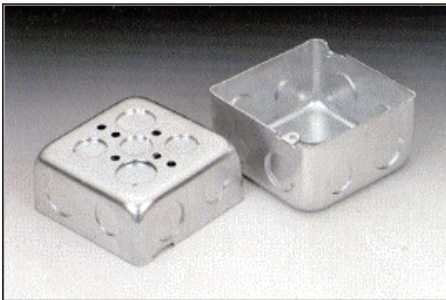

9.6.7 Concealed Box (Emergency Switch)

